

Thank you for purchasing Nippon Antenna product. Please read this manual carefully before using the product and heed the instructions. Please keep this manual at safe place for future use.

Features:

- Thanks to Nippon Antenna Technology “Twin Radiator System” realized the high performance for capturing the UHF Terrestrial Digital TV Signals. At the same time, it made possible for the slim design.
- The specially designed stand (Included) made possible to use it indoor as well.
- Include the mounting kit for installing this antenna on the outdoor antenna mast.



Indoor Stand

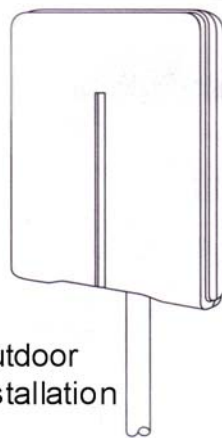

Outdoor Installation

Specifications

Receiving Channels	14~69 Ch.
Receiving Frequencies	470~806 MHz
Operating Gain	3.5~6 dB
Impedance	75 Ohm
Standing Wave Ratio	Less than 3.0
Half Power Width	Less than 80°
Front Rear Ratio	More than 14 dB
Wind Effective Area	0.08 m ²
Mast Diameter	φ 22~50 mm
Mass (Body)	1.0 Kg
Dimensions [mm]	261W x 319H x 52D

The structure and the name of each parts.



Antenna Body



4 x Mounting Screws
(On the Antenna Body)



1 x Indoor Stand
(with the mounting screws)

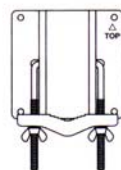

1 x Mast Mounting Plate



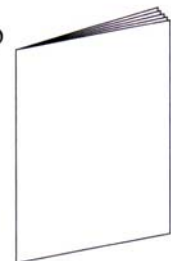

1 x Water Resistant Cap





1 x Instruction Manual



To: Customers, for avoiding any accidents, please consult the specialist for installing this antenna.

Cautions and Safety notice.

-  This mark indicates the Cautions and Warnings. There will be the specific cautions and warning with this mark.
-  This mark indicates the warnings for "Not do items". There will be the specific cautions and warning with this mark.
-  This mark indicates the "Must do items". There will be the specific cautions and warning with this mark.
-  This mark indicates the Cautions and the warnings that might cause injuries, death, or damages to properties if ignored. There will be the specific cautions and warning with this mark.

Do not touch the cable during the lightning storm 

-  The Cautions and the warnings that might cause injuries, death, or damages to properties if ignored.

During the storm, there some possibilities that the screws and cable may come loose. Please consult  the specialist for the regular maintenance.
Do not hang laundries or any object on the antenna. 

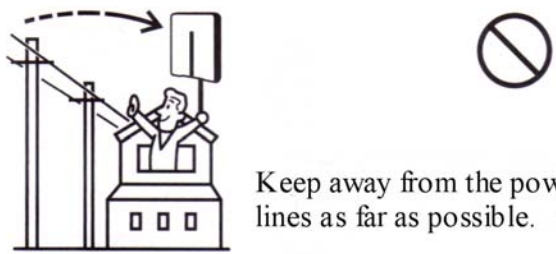
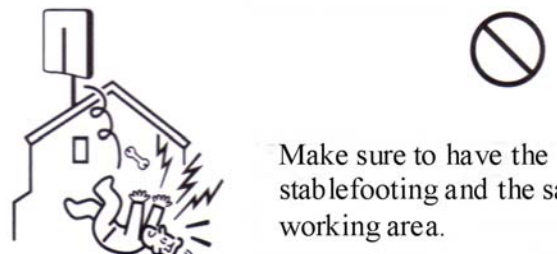
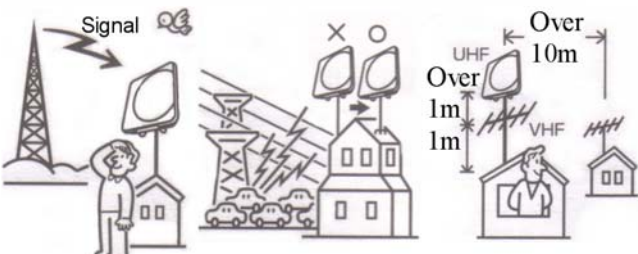
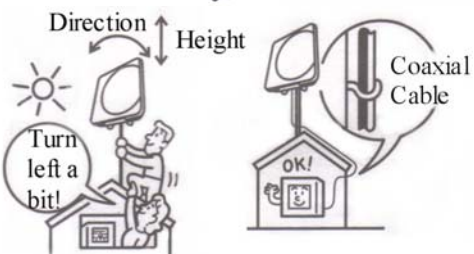
	
Keep away from the power lines as far as possible.	Make sure to have the stablefooting and the safe working area.
	
Position the antenna at the direct sight from the transmission tower	Adjust the antenna for the best reception.
Keep away from the noise source (power line, Neon light, Cars)	Keep the coaxial cable from the roof or eves trough
Keep away from other antenna.	

Operating cautions:

You may not get the best performance or get the interferences if the antenna is located at the behind of buildings or the spots where the signal is weak.
This is a terrestrial digital antenna. This antenna may cause ghost noise if you use this for the analog broadcasting.
Please choose the best location for using at indoor.

Installations

Required tool: Philips driver.

Attach the stand on the antenna main body using the two screws (2 x 4 mm Screws)

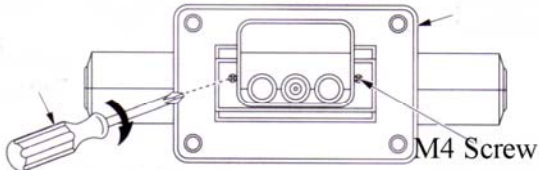

Philips screw driver
Tightening torque M4: 1.18 N-m (or 12 K gf-cm)

Receiving Horizontal polarization signals

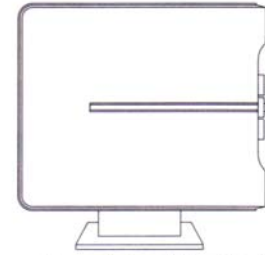
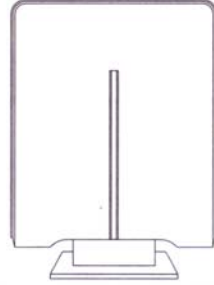

Receiving Vertical polarization signals

Outdoor installation

On the mast installation

Position the antenna main body according to the polarization of TV signals and attach the mounting plate as shown in the picture below.

Use 4 x 5 mm screws, Tightening torque 2.45 N-m. (or 25Kgf-cm)

Receiving Horizontal polarization signals

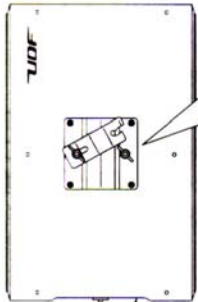

Do not put this side up

Receiving Vertical polarization signals

Do not put this side up

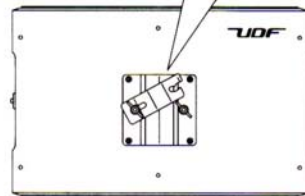
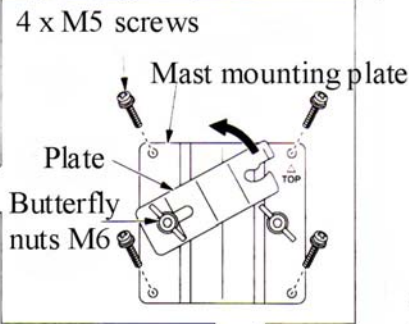

Do not put this side up

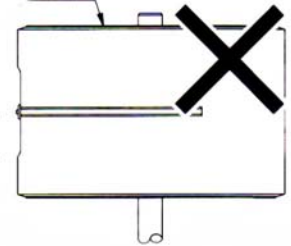

Water drainage is placed on one side, so do not put the side up.

Attach the mounting bracket on the antenna body and lightly tighten the butterfly nuts, after adjust the antenna for the best reception then tighten the nuts.

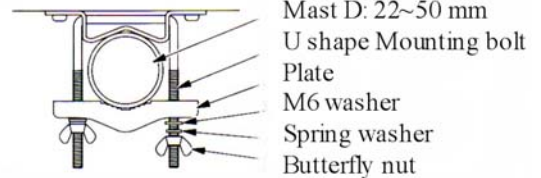

Antenna adjustment

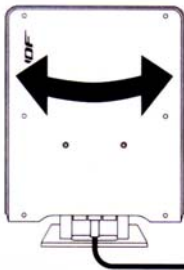

Move the antenna direction for the best reception.

TV with Built-in Digital tuner

Cable



Connect the antenna and the TV with (The Digital tuner built-in) the cable and Tune a Digital TV channel. If you can get the signal, then the installation is completed.

Connecting the cable

Preparing the cable and attaching the connectors to the cable.

- Do not make short circuit with the center conductor and the shield mesh conductor.
- Do not leave any scratches on the conductors. The conductors are very sharp; so do not puncture your fingers.
- We recommend to use S-5C-FB, S-7C-FB or equivalent cable.
- Use proper connectors for the cables.

Required tools:

Cutter or Knife, Scissors, wire cutter, or Pliers

Parts names

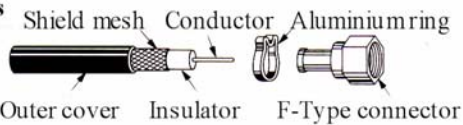

If you use the FB type cable (Aluminium shield type), process same as the mesh type.

Put the water resistant cap first

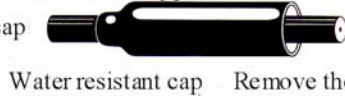

1- Cut the outer cover as the dotted line as shown in this picture.



2- Remove the outer cover and through the aluminium ring



3- Cut off the shield mesh 2mm from the outer cover.



4- Put the shield mesh over the outer cover



5- Cut the insulator off at 3mm from the shield mesh shown in the picture insert the F-Type connector between the insulator and the shield mesh and secure with the aluminium ring



7- Cut the centre conductor slanted, and leaving 2mm from the edge of connector.

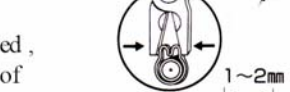

Do not leave the centre conductor too long, it may damage the connector.

Note: Make sure the connector and the conductors are clean before connecting.

Use the cable with the centre conductor diameter less than 1.5mm.

Connect the cable to the output terminal and tighten (Tightening torque 2.0 N·m or 20 Kgf·cm) with pliers. Then cover the connector with the water resistant cap pushing tightly to the antenna body. Additional protection with teflon tape / Vinyl tape may be required for the area with heavy rains and salt solutions. Cover with the tapes then covering with the water resistant cap

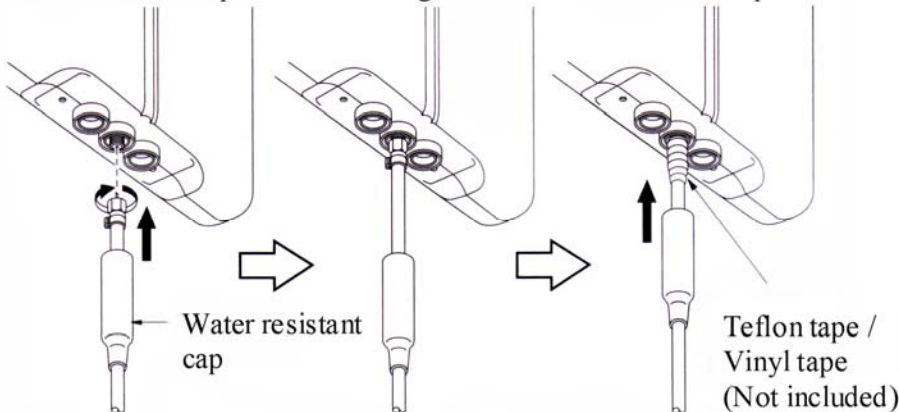

We recommend to use the L-shaped connector for Indoor use.

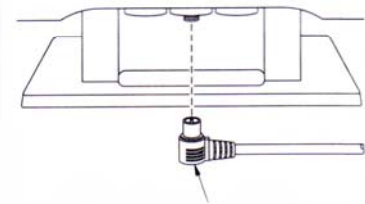

L-Shape push plug or L-Shape screw type plug.

90 DAY LIMITED WARRANTY

Nippon Antenna Company warrants this product against any defects in materials or workmanship within 90 days from date of purchase.

No warranty claim will be honored unless at the time the claim is made; you present proof of purchase to an authorized Nippon Antenna Company dealer

(If unknown, please contact Nippon Antenna Distributor Karmond Company in Canada)

Nippon Antenna Company will either repair or replace the defective product at no charge to you. This warranty covers parts, but does not cover any costs incurred in removal, shipping or reinstallation of the product.

This limited warranty does not apply if the product is damaged, deteriorated, malfunctions or fails from: misuse, improper installation, abuse, neglect, accident, tampering, modification of the product as originally manufactured by Nippon Antenna Company, usage not in accordance with product instructions or acts of nature such as damage caused by wind, lightning, ice or corrosive environments such as salt spray and acid rain.

The 90-Day Warranty is provided on the condition that the equipment is properly delivered with all handling and freight charges prepaid to your Nippon Antenna dealer for return to our distributor for repair or replacement. Nippon Antenna Company dealers will arrange for the replacement or repair and return to you without charge the product that failed due to defective material or workmanship.

NIPPON ANTENNA COMPANY WILL NOT ASSUME ANY LIABILITIES FOR ANY OTHER WARRANTIES, EXPRESS OR IMPLIED, MADE BY ANY OTHER PERSON. ALL OTHER WARRANTIES WHETHER EXPRESS, IMPLIED OR STATUTORY INCLUDING WARRANTIES OF FITNESS FOR A PARTICULAR PURPOSE AND MERCHANTABILITY ARE LIMITED TO THE 90-DAY PERIOD OF THIS WARRANTY.

The foregoing shall be the sole and exclusive remedy of any person, whether in contract, tort or otherwise, and Nippon Antenna Company shall not be liable for incidental or consequential damage or commercial loss, or from any other loss or damage except as set forth above.

Some states do not allow limitations on how long an implied warranty lasts, or the exclusion of limitation of incidental or consequential damages, so the above limitations or exclusions may not apply to you.

This warranty gives you specific legal rights and you may also have other rights, which vary from state to state and Canada.

Karmond Company (North American Distributor)
Nippon Antenna Company